

**Model  
HB320A**

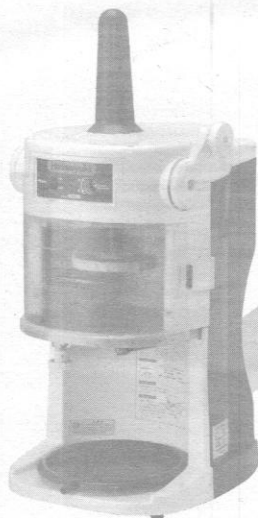

**Model  
HF-700P2**

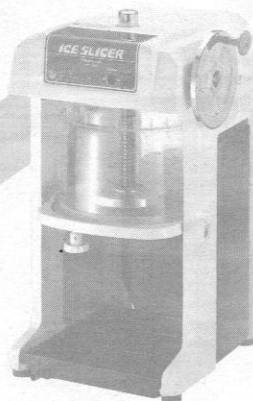

## **Hatsuyuki Block Ice Shaver**

**Model  
HF-300P2**





### **TRANSFER (RE-SALE) OF MACHINE**

Should you sell or give the machine to a 3rd party, make sure that this "OPERATION MANUAL" goes with it for safe and correct operation.



- \* Before operating this machine, please read and understand the instructions specified in this manual for proper and safety use.
- \* Retain this manual for your immediate and future references.
- \* For maintenance and repairs, please contact the manufacturer (Chubu Corporation) or the local distributors from whom you purchased the products.

- Before operating the machine, please read the following "Instructions for Safety" in the manual very carefully, and operate the machine correctly.
- Each instruction specified in the manual is very important for safety, so be sure to follow each instruction as specified.
- Attention marks and their meanings are as follows:

	<b>WARNING</b> Incorrect operation of machine is dangerous and can cause serious injury or death.
	<b>CAUTION</b> Incorrect operation of machine is dangerous and can cause injury of person or material damages.

Note: "Material damages "means damages to buildings, furniture and effects, pets, etc.

### Examples of Mark / Pictograph:

 Electric Shock	△ represents "CAUTION" (including danger and warning). The specific contents of caution are shown near the △ mark by pictograph or letters. The mark illustrated left represents "ELECTRIC SHOCK".
 Do Not Disassemble	⊘ represents "PROHIBITED OPERATION". The specific contents of "Prohibited" are shown within or near this ⊘ mark by pictograph or letters. The mark illustrated at left represents "DO NOT DISASSEMBLE".
 Unplug	● represents "ENFORCEMENT" (Things to do). The specific contents of "Enforcement" are shown within or near ● the mark by pictograph or letters. The mark illustrated at left represents "Unplug from outlet".

## WARNING

### ● Be sure to ground (earth) the machine.

Never connect a ground wire (earthing) to gas pipes, water pipes, lightning rods or telephone cord/grounding wires. An incomplete grounding (earthing) is dangerous and can cause severe electric shock.

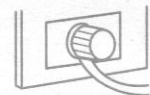

### ● Dedicated (Exclusive-use) outlet.

Always use an outlet dedicated to each machine. Never use extension cords or connect the unit to other power supply cords. Never connect several or many plugs into the same outlet. It may cause power supply cord to overheat and melt/burn or electric shock or fire.

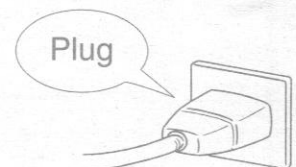

### ● Do not operate the machine outside.

Operating the machine outside or in the rain will cause electric bleeding or electric shock.



## WARNING

- **Do not install the machine in a damp or wet place.**  
It can cause electric bleeding or electric shock.

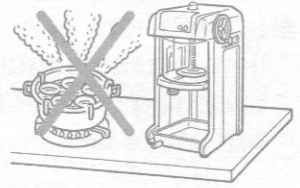

- **Do not install/place the machine close to any heating appliance.**

Never install/place the machine close to any heating appliance such as a gas burner. It can cause melting and/or burning of plastic cover.

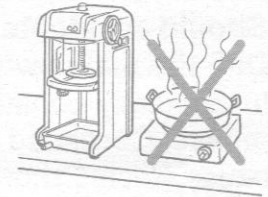

- **This machine is for "COMMERCIAL USE".**

This appliance can be used by children aged from 8 years and above and persons with reduced physical, sensory or mental capabilities or lack of experience and knowledge. If they have been given supervision or instruction concerning use of the appliance in a safe way and understand the hazards involved.

Children shall not play with the appliance.

Cleaning and user maintenance shall not be made by children without supervision.



- **Do not pour water over the machine or immerse machine in water.**

It can cause a short circuit or electric shock, as well as rust and other water related problems.

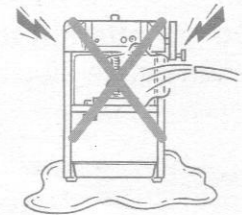

- **Do not damage power supply cord.**

Never work on power cord and never pull, twist or bundle it. Do not place a heavy things on it. It can damage the power cord and can cause electric shock or fire.



- **Keep plug clean and plug into outlet correctly.**

Always keep plug clean and plug into outlet correctly. Dirty plugs or imperfectly connected plugs can cause electric shock or fire.



Attention to Dust.

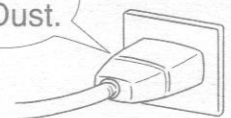

- **Do not touch any electrical parts (such as plug or switch) with wet hands.**

It can cause electric shock.

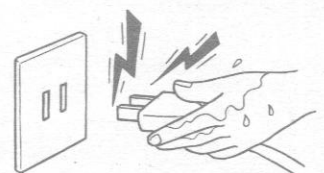

## WARNING

- **In the event of circuit breaker moving to "OFF" position, please contact the machine vendor.**

Switching breaker to "ON" position incorrectly or by force can cause electric shock or fire.



- **Should accidents or irregular operation occur, TURN OFF the main switch and unplug from outlet.**

Immediately contact your machine vendor for a correct repairs. Continued operation of a faulty machine can/will cause electric shock or fire.



- **For cleaning inside the ice hopper or changing blades, be sure to TURN OFF the main switch and always put on gloves while cleaning/changing blade works.**

Never touch blades directly. They are very sharp and can cause injury.



- **Never try to disassemble or repair the machine by yourself.**

Always call a qualified technician. Incorrect repair will likely cause irregular operation or electric shock, fire or injury.

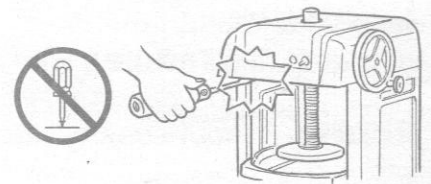

- **Do not attempt to alter the machine in any way.**

It can cause electric shock or fire.

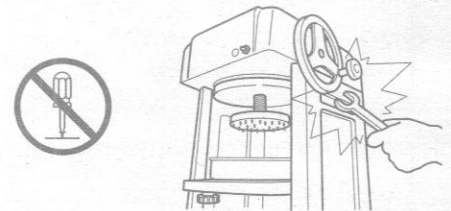

- **Do not open the sliding door or put your hand into the chamber during operation.**

Lower the blade tip below the shaving table when cleaning the inside of the chamber. Wipe the shaving table counterclockwise to the blade direction. Otherwise, injuries could occur.

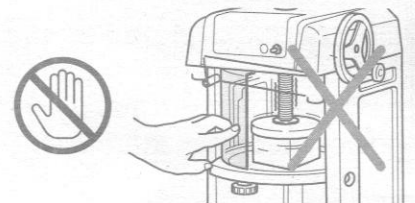

## ⚠ CAUTION

- **Always install the machine on a stable and flat surface.**  
Irregular or imperfect installation can cause the unit to tip or fall and is therefore dangerous.

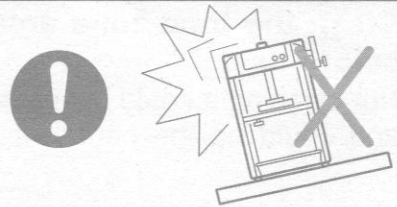

- **Install the machine in a location unaffected by occasional dripping of water.**  
Melting ice will drip and can, therefore, drip onto things surrounding the machine.

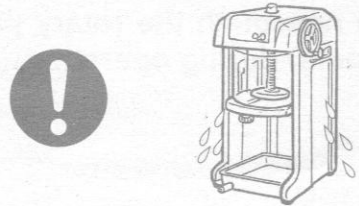

- **Keep the machine away from direct sunlight.**  
It can cause a damage to plastic parts.

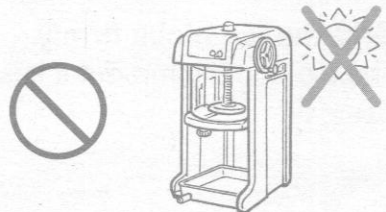

- **When cleaning, be sure to switch OFF and unplug the unit before doing so.**  
Cleaning with the power or switch on is very dangerous and can cause electric shock or injury.



- **Never use inflammable sprays near the machine and never place volatile or inflammable materials close to the machine.**  
Sparks from the switch could possibly cause fire.

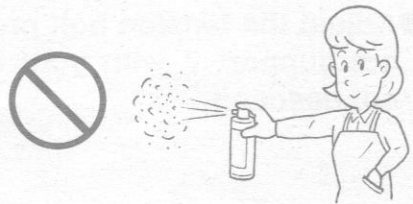

- **When you unplug the unit, be sure to hold the plug while you pull it out of the outlet.**  
Never pull the power cable. It may damage the plug/cable and can cause electric shock or fire.

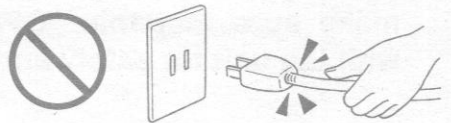

- **After the day's business is finished, be sure to switch OFF and unplug the unit for safety.**

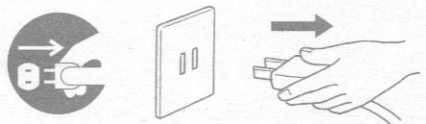

- **For disposal of disused unit, please contact local disposal experts or the nearest vendor.**  
Abandoned machines are dangerous. Treat blade on machine as a dangerous item when disposing machine.

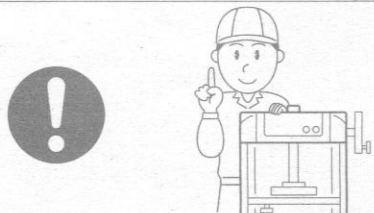

## ⚠ CAUTION

- **Clean the food zone area in the shaving chamber before use.**

Not cleaning it could increase the chance of contamination and could be the cause of illness.

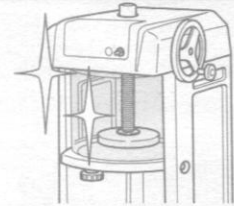

- **Do not touch the rotary parts (main shaft and crank handle) during operation.**

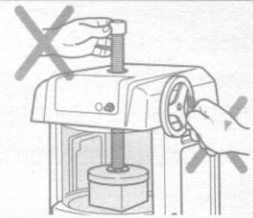

- **Grip the ice block firmly.**

The ice could jump out if it is not positioned firmly.

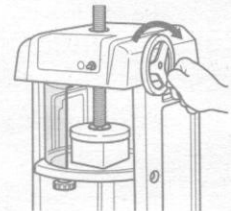

- **Do not touch the prongs with your fingers.**

Doing so could cause injury.

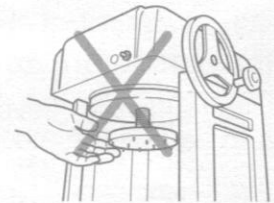

- **Adjust the tension bolt properly so that when you do not support it with your hand, the ice holder does not descend.**

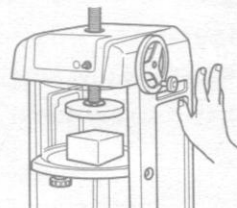

- **When you sell or give the machine to a 3rd party, make sure that this "OPERATION MANUAL" goes with the unit for safety and correct operation.**



# PART NAMES AND FUNCTIONS

# 2

● This machine is commercial block ice shaver to produce shaved ice from a block of ice - a dice of 13 cm approx. Use a block of ice and never use other items.

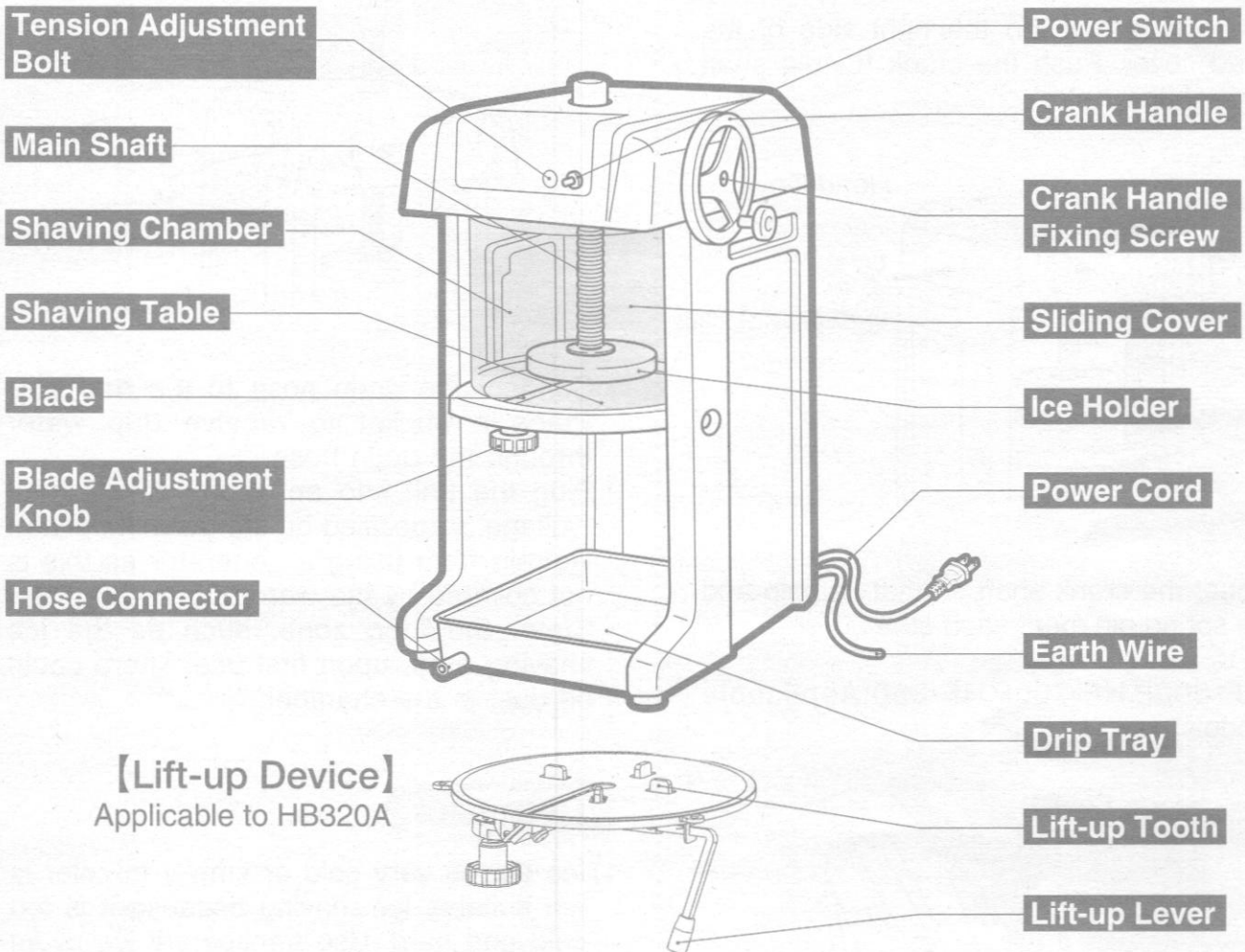

## ACCESSORIES

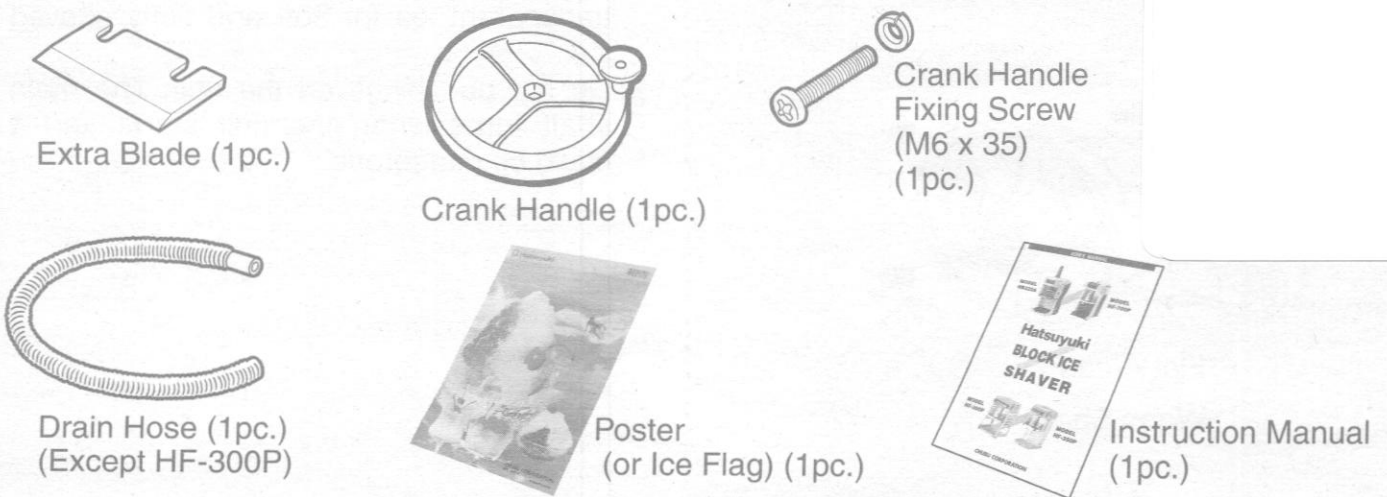

## CHECK BEFORE OPERATION

• Attach the enclosed crank handle in the following manner:

- 1) There is a hole on the right side of the head cover. Push the crank handle shaft through this hole.

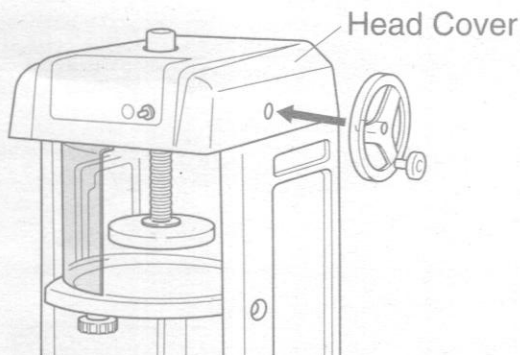

- 2) Mount the crank shaft so that its chip and the spring pin meet each other.

(HF-300P, HF-700P, HF-350; Applicable Models)

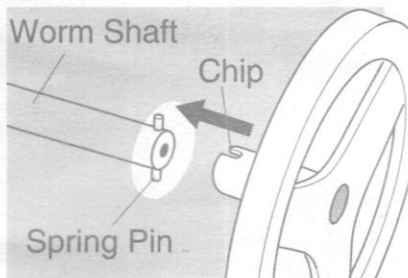

(Model HB320A)

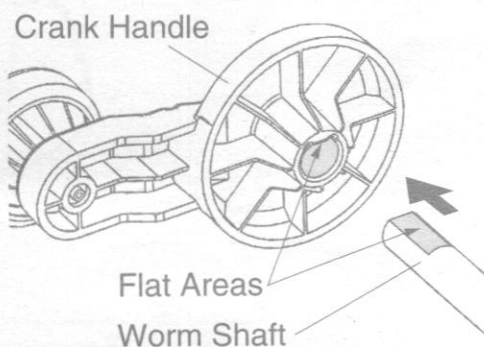

- 3) Insert the Phillips screw through the crank handle and fasten it firmly using a screwdriver. Check the handle to make sure it smoothly moves the main shaft up and down.

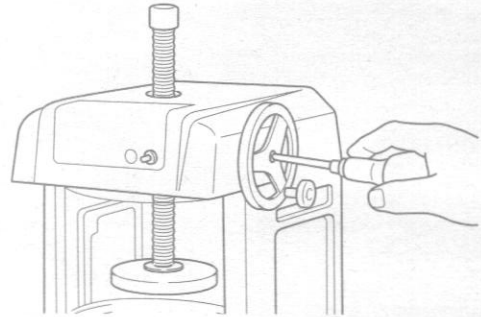

- Connect the drain hose to the drip tray. Place a bucket to receive drip water through the drain hose.
- Plug the unit into an appropriate socket (voltage is specified on the machine plate). Refrain from using a generator as this is not covered by the warranty.
- Clean the food zone, such as the ice shaving area, upon first use. There could be dust in the chamber.

## Remarks

- 1) Ice that is very cold or smoky in color is not suitable for shaving because it is too cold and hard. Use transparent ice of an appropriate temperature. Ice that is smoky in color will not produce soft and fluffy shaved ice. It could damage the blade tip and the blade will not shave the ice. Use transparent ice for soft and fluffy shaved ice.
- 2) Do not put things on the unit. The main shaft turns when the unit starts and it could be dangerous.



## OPERATION INSTRUCTIONS

- 1) Plug the machine in. Make sure the power switch is turned to the off position before plugging in the unit.

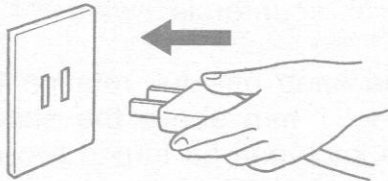

- 2) Place a block of ice on the shaving table.

- Move the sliding cover to the left to open. (HF-300P / HF-700P / HF-350P)

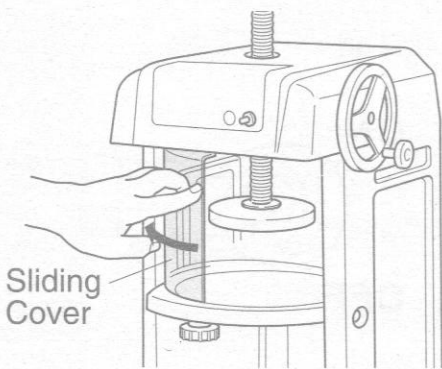

- Open the shaving shield. Push it slightly to release the catch and draw it open. (HB320A)

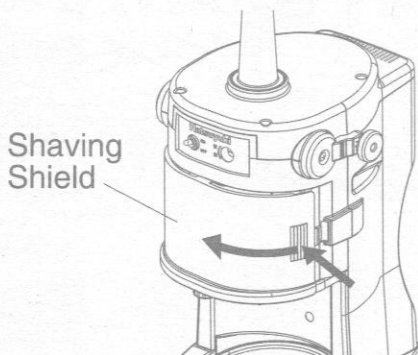

- Turn the crank handle counterclockwise to raise the ice holder.
- Ensure the crank handle is free and that it does not fall down. If it falls down, it is dangerous. Tighten the tension bolt clockwise (read "About the Tension Adjustment Bolt" on page 11).

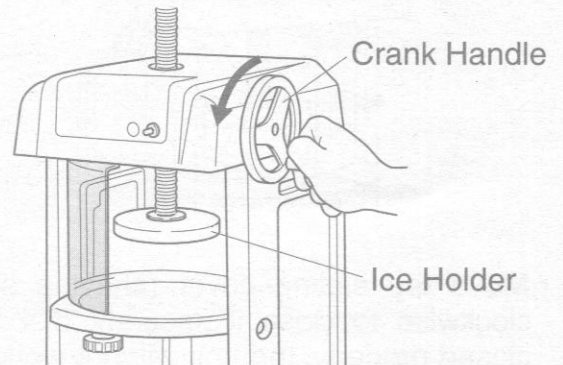

- Draw the lift-up lever upwards to hide the lift-up teeth under the table. Then place a block of ice on the center of the shaving table (Model HB320A).

Holes for Lift-up Teeth

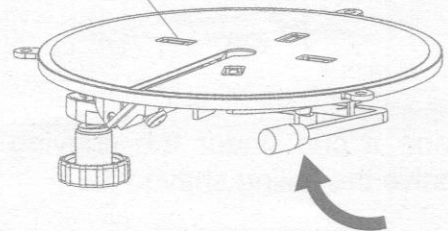

- Place a block of ice on the center of the shaving table. The ice should not exceed the area of the shaver blade. Otherwise, the ice will not be shaved well or it will be shaved improperly and might jump out. Keep your hands away.

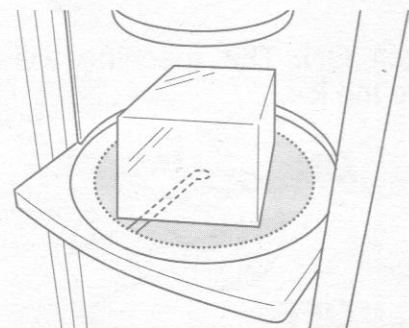

# HOW TO USE

# 3

- Turn the crank handle clockwise to lower the ice holder and let its prongs grip the ice firmly. If the ice is not firmly gripped, it could jump out.

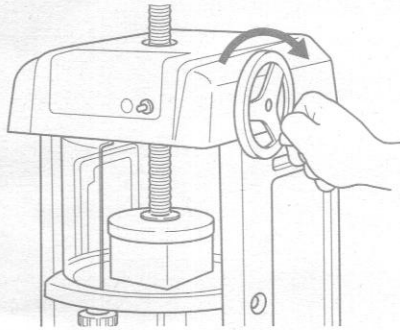

- Move the sliding cover (shaving shield) clockwise to close it securely. If it is not closed properly, the unit will not work even though it has been turned on.

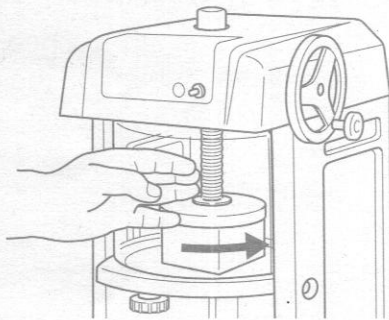

- 3) Place a cup under the shaving table to receive the falling shaved ice.

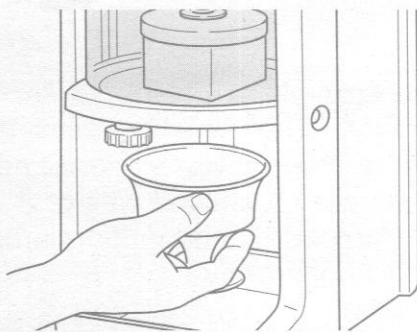

- 4) Switch ON. The machine will begin to shave the ice.

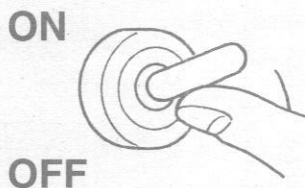

- 5) Adjust the texture of the shaved ice. Turn the blade adjustment knob for the desired ice texture. Standard shaved ice texture is 1 millimeter (mm), as this is the pitch between the blade tip and the shaving table.
  - Turn the knob clockwise for a coarser texture or counterclockwise for a finer texture.
  - Turn the knob one full rotation to raise the blade 1 mm above the shaving table. The knob can be turned two or three times.



- 6) Turn the unit off.

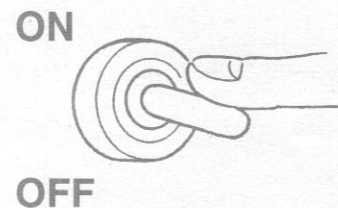

- 7) Unplug the unit when you are finished.

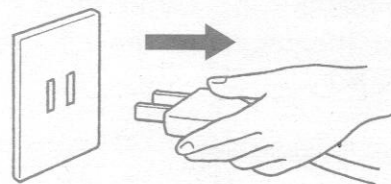

## TAKING THE ICE OFF THE SHAVING TABLE

### ⚠ WARNING

In order to avoid injury, do not touch the blade tip when putting ice on the shaving table or when removing ice from the shaving table.



### ⚠ CAUTION

Do not touch the prongs of the ice holder. They could cause injury.



● Follow these steps:

1) Switch the unit off and turn the crank handle counterclockwise to raise the ice holder.

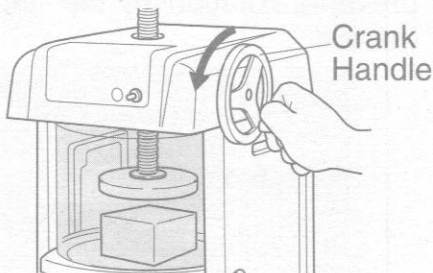

2) Confirm the ice holder does not descend when you remove a supporting hand from the crank handle.

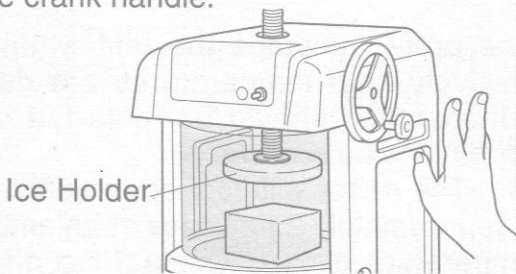

3) Move the sliding cover (shaving shield) counterclockwise to open.

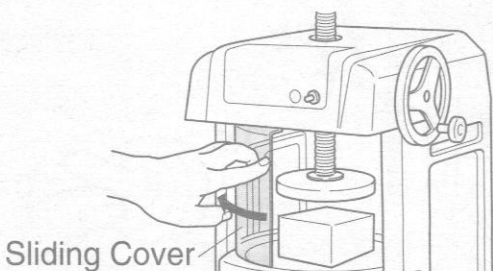

4) Press the lift-up lever down to raise the ice above the shaving table. Then remove the ice. (HB320A)

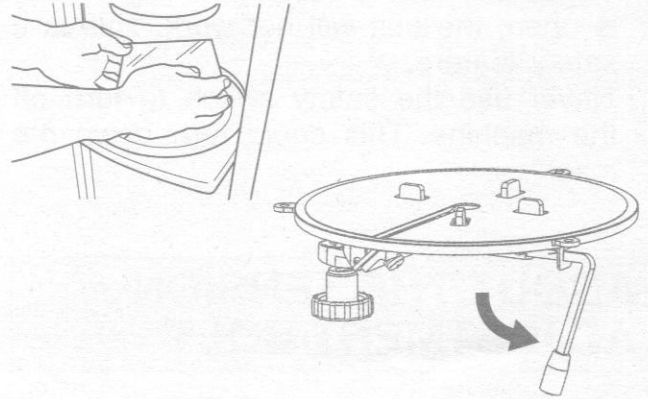

5) Turn the crank handle clockwise to lower the ice holder. Close the sliding cover (shaving shield). This is for safety reasons.

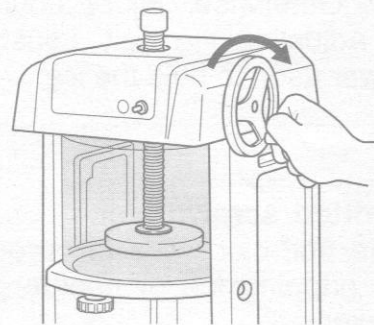

## TEMPORARY PRESERVATION OF ICE (HB320A)

Model HB320A has a temporary ice preservation function so that the ice will not melt too quickly.

- Turn the crank handle counterclockwise to raise the main shaft. (Drawing above 1)
- Press the lift-up lever down to raise the ice above the shaving table.

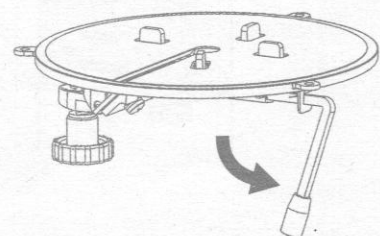

## ABOUT THE SAFETY SWITCH

- When the sliding cover (shaving shield) is open, the unit will not work. This is a safety feature.
- Never use the safety switch to turn off the machine. This could turn down the machine.

## ABOUT THE TENSION ADJUSTMENT BOLT

### ⚠ CAUTION

Adjust the tension adjustment bolt not to descend when you remove a supporting hand from the crank handle. Otherwise, injury could occur. Adjusting the bolt adjusts the power used to hold the ice.



### Use a slotted screwdriver.

- Turn the bolt clockwise for stronger tension of gripping ice or counterclockwise for weaker.
- Confirm the adjustment by turning the crank handle. Recommended tension is such that the ice block holder does not descend when you remove a supporting hand from the holder, yet it doesn't feel heavy or tight when the handle is moved to lift the holder.

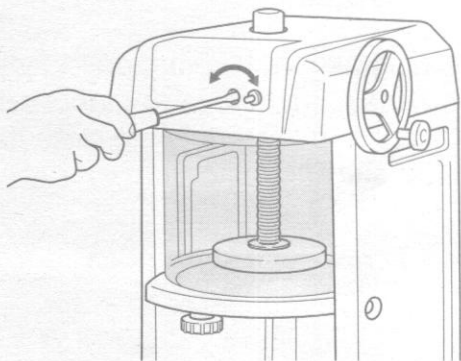

## ABOUT THE PROTECTOR

(Not applicable to HB320A)

- When the motor is overloaded, the protector causes the machine to stop automatically.
- A protector is installed in the motor.
- Follow the instructions below when the protector is activated (the red button pops out).

ON



OFF

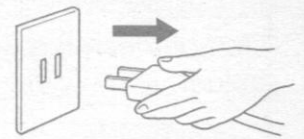

- (2) Remove the cause of the overload (e.g., the blade catches the ice too deeply and prevents rotation of the ice). Reposition the ice.

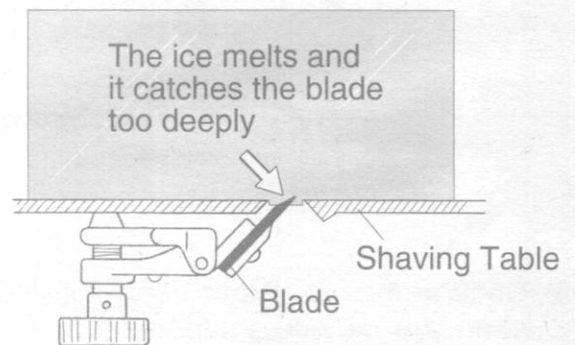

- (3) The protector stops the unit when excessively high temperatures are detected. Operation should be restarted once the motor cools down.

Note: The motor will cool down sufficiently in approximately 20 minutes at an ambient temperature of 20°C. Contact the distributor or an authorized mechanic if the protector mechanism works too frequently.

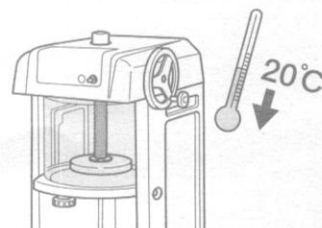

ON



OFF

# HOW TO CHANGE BLADES

# 4

## ⚠ WARNING

Switch OFF and unplug the unit when changing blades or during cleaning and maintenance. 

Use gloves and do not touch the blade tip directly. Otherwise it could cause injury. 

## REMOVING THE BLADE AND ATTACHING THE BLADE

- 1) Switch off and unplug the unit.

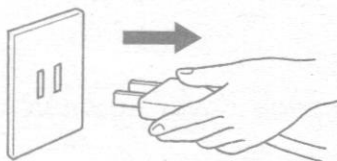

- 2) Move the sliding cover to the left to open.

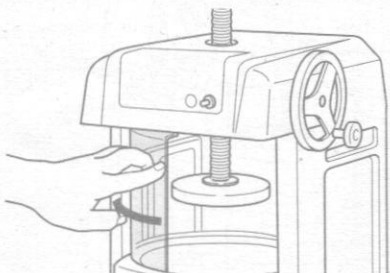

- 3) Raise the crank handle counterclockwise to raise the ice holder.

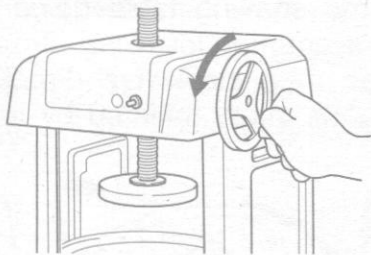

- 4) Loosen the two Phillips screws that fasten the blade.

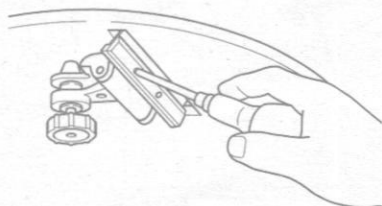

- 5) Remove the blade upwards through the opening of the shaving table.

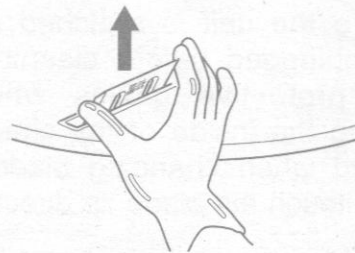

- 6) Turn the blade adjustment knob completely counterclockwise until it stops and then turn it back clockwise by half round for easier installation of a new blade.

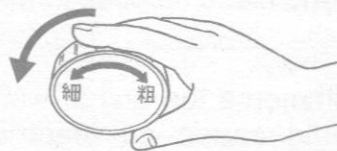

- 7) Position a new blade that its engraved mark "初雪 (Hatsuyuki in Japanese)" faces the ice holder and insert it between the blade holder and the ice receiver from the opening of the shaving table.

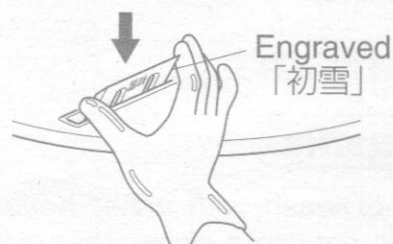

- 8) Position the blade tip and the shaving table at the same height and level. Then fasten them firmly.

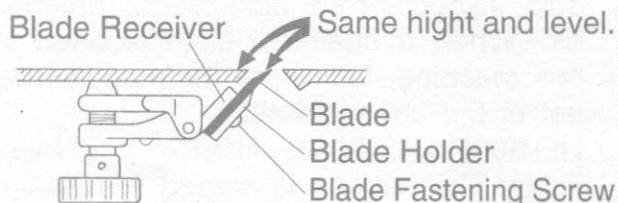

- 9) Turn the blade adjustment knob clockwise for the desired shaved ice texture (turn it clockwise for a coarser texture).



## ⚠ WARNING

Be sure the unit is switched off and unplugged before cleaning. Wear protective gloves when cleaning the inside of the chamber and when changing blades. Do not touch the blade tip directly.



Lower the blade below the conical case surface when cleaning the inside of the chamber. Wipe the shaving table counterclockwise (against the blade tip direction).



Do not immerse the unit in water. This could cause an electrical short circuit, rust, or permanent damage to the unit.



Do not touch the power switch, plug, or other electric parts with wet hands.



## Remarks

- Do not wash with water hotter than 40 °C. Do not use a dishwasher or dish dryer, as these may cause plastic parts to warp.
- Do not use the followings on plastic parts: benzine, alcohol, petroleum, powdered soap, polishing powder, alkaline detergent, acid, hypochlorous acid, scrub brushes, etc. When a chemical cloth is used for this machine, follow the instruction manual of the chemical cloth.
- HF-300P, HF-700P, HF-320A Shaving Table: The surface is coated with fluoroplastic. Do not use hard scrub brushes or coarse cleansers.

## DAILY MAINTENANCE

- Inside Ice Shaving Chamber (including the shaving table, slide cover etc.):
  - 1) Turn the blade adjustment knob completely counterclockwise to lower the blade behind the surface of the shaving table. Otherwise, it could injure your fingers.

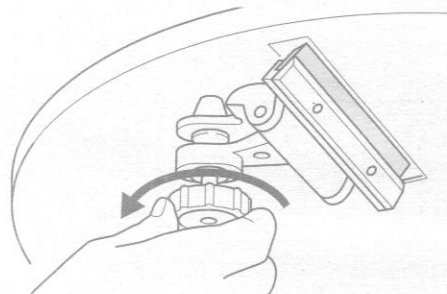

- 2) Turn the slide cover counterclockwise to open it.

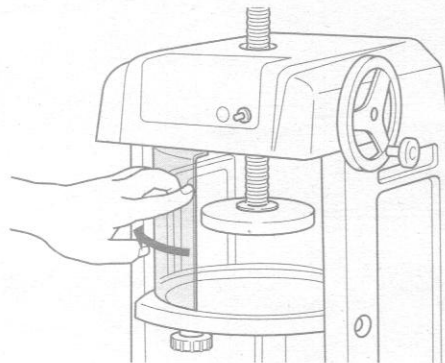

- 3) Clean the shaving table using a damp cloth in a counterclockwise direction. Do not clean in a clockwise direction; this could cause injury inflicted by the blade.

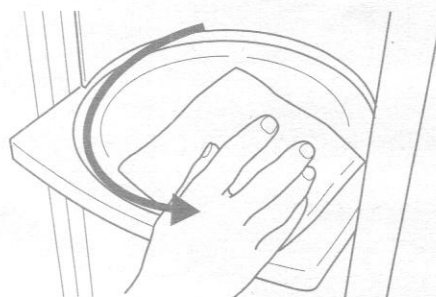

4) Clean the inside of the slide cover using a damp cloth (HF-300P, HF-350P, HF-700P).

(HB320A - Clean after the shaving shield is removed.)

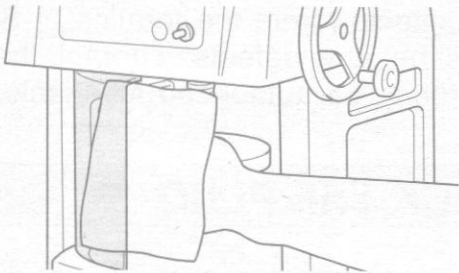

## REMOVAL OF THE SHAVING TABLE (HB320A)

- Lower the blade behind the surface of the shaving table (see daily maintenance instructions).
- Remove the two shoulder screws (M4).
- Push the lift-up lever toward the inside.
- Raise the shaving table and take it out.
- To mount the shaving table, reverse the order of the above.

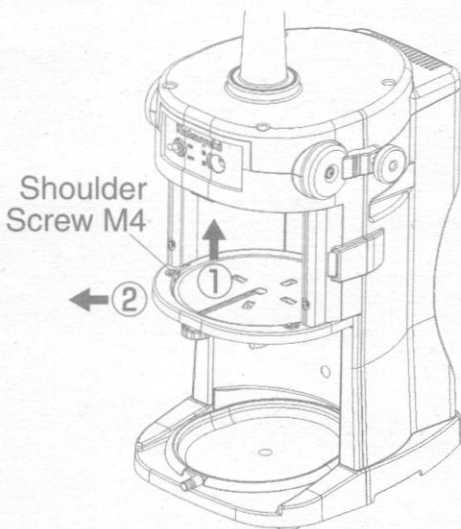

## CLEANING(COVERS)

- Wipe covers using a soft, dry cloth.
- Clean hardened dirt using a damp cloth and warm water. A gentle dish detergent can be used. Be sure to completely remove any traces of detergent with a damp cloth.

## MONTHLY MAINTENANCE

- Lubrication - Use the gear oil included as a standard accessory.
- 1) Turn the ice holder completely clockwise to the bottom. Remove the Philips screw that fastens the crank handle (HF-300P, HF-350P, HF-700P).  
(HB320A - Removal of the crank handle is not necessary.)

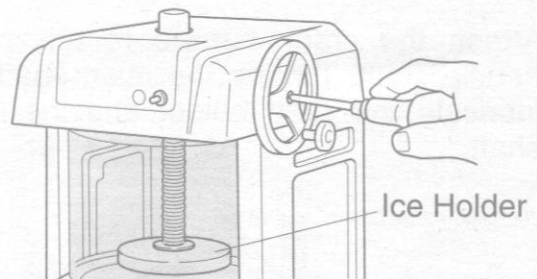

- 2) Remove the Philips screws fastening the head cover. o

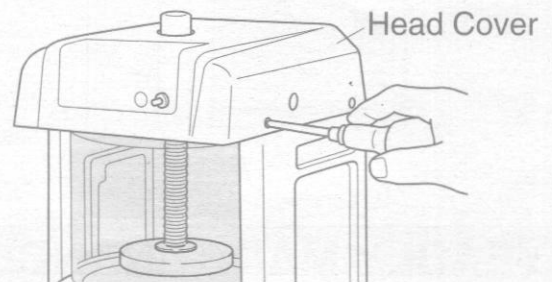

- 3) Temporarily insert the crank handle into the worm gear shaft. Lubricate the following parts, turning the crank handle:
  - the two holes of the upper part of the worm gear shaft holder
  - the contact point between the Y-brake and the worm gear

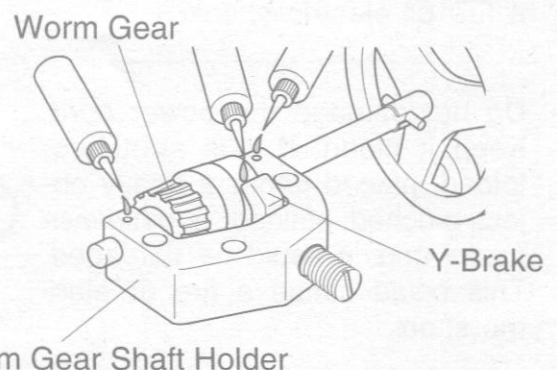

4) Attach the head cover using the screws.

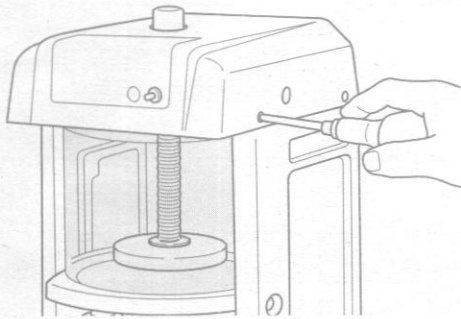

5) Attach the crank handle to the crank handle shaft. Turning the main shaft will lubricate the shaft holder and the main shaft.

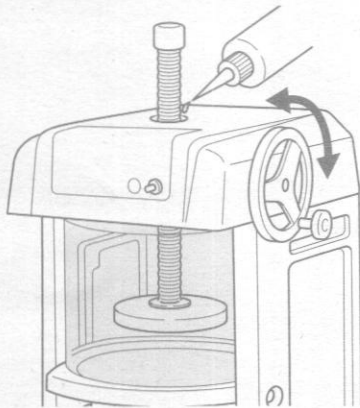

## MAINTENANCE OF GROUNDING THE MACHINE

- Check that the earth wire is not cut or disconnected from the terminal. \* Should there be any defects, contact the distributor or an authorized mechanic.

## CHECK THE PLUG

- Use an exclusive socket.
- Confirm there is no dust on the plug prongs or the socket.
- Do not use a power cord that is damaged in any way. Should there be anything irregular, contact the distributor or an authorized mechanic.

## PRESERVATION

- To warehouse or store the machine for more than one week, dry it completely and keep the machine in a place free from moisture.

## YEARLY MAINTENANCE

### ⚠ WARNING

Periodically confirm there is no dust on the plug prongs or blade attachments. Periodically plug in the unit to check it works. An improper connection could cause a fire or electric shock. ⚠

Do not damage the power cord. Keep it clean. If it is stretched, folded, placed under a heavy object, pinched, stained, or otherwise mistreated, it could be damaged. This could cause a fire or electric shock. ⚡



## TROUBLE SHOOTING

- The machine should be serviced by the distributor or an authorized mechanic.

Problems	Things To Check	What To Do
The machine does not start.	Is the plug connected to the socket?	Connect to the socket.
	Is the protector working?	See page 11 - About the Protector.
	Is the belt mounted properly?	Contact the distributor.
	Is the slide cover (shaving shield) open?	Close the slide cover (shaving shield) completely.
	Is the motor loaded heavily?	Switch OFF. Remove the cause.
The machine works, but does not shave ice well.	Is the blade dull?	Replace the blades (see Page 12).
	Is the blade adjusted properly?	Turn the blade adjustment knob clockwise to raise the blade.
	Is the tension bolt loose?	Turn the bolt clockwise for increased tension.
Ice moves away from the ice holder during shaving.	Is the tension too loose?	Turn the tension adjustment bolt clockwise.
	Do the prongs of the ice holder not catch the ice?	Drop the ice holder a bit more so the prongs grip the ice firmly.

## TRANSFER AND DISPOSAL

- When selling or transferring this product to a third person, tape this instruction manual to the machine. This will ensure the new owner has all the instructions.
- Refer to a qualified service or your local dealer when discarding the product. Abandoned products are dangerous and can result in injury. Blades are dangerous and require proper disposal.

# SPECIFICATIONS

# 6

Model	HF-300P2	HF-700P2	HB320A
Rated Power Consumption	130/115 W	130/115 W	130/115 W
Shaving Capacity (kg/minute)	1.8/2.2	1.8/2.2	1.7/2.1
Effective Diameter for Shaving(mm)	200	200	200
Unit Dimensions (W×D×H mm)	350×402×580	345×425×574	355×402×756 (*1)
Net Weight (kg)	27	21	20
Electrical	230V, 1Ph, 50/60Hz		
Standard Accessories	Extra Blade..... 1 Drip Tray ..... 1 Gear Oil ..... 1 Crank Handle..... 1	Crank Handle Fixing Bolt (M6 x 35)..... 1 Drain Hose (Except HF-300P) ..... 1 Poster (or Ice Flag)..... 1 Instruction Manual ..... 1	

\*1. (The height includes the shaft cover.) <561mm H up to the head cover>

## Remarks

The shaving capacity is shown under the standard shaving conditions.  
 (The blade tip arises 1mm above the shaving table.)